



Rockwool  
Flexi®

## The perfect friction fit for framed constructions

Rockwool Flexi® is a unique, flexi-edged insulation product, specifically developed using patented technology for a fast and easy, perfect friction fit between timber and metal frame systems.



The following NBS clauses include Flexi: p10:140, p10:210, p10:230, p10:240, p10:250, k10:115, k10:125, k10:145, k10:155, k10:165, k10:185, k10:420, k11:215, k11:225, k11:235, k11:245, k20:150, k20:160, m10:290, m13:260

# Rockwool Flexi®

Rockwool Flexi® slabs ensure essential tight fitting for thermal and acoustic integrity between frames in walls, partitions, floors and roofs, without the need for cutting or waste. Made from renewable volcanic rock, they are extremely fire resistant and significantly reduce the carbon footprint of a building.

## Advantages

- Outstanding thermal, acoustic and fire properties
- Flexi edge offers accurate fit to all widths
- Multi-application; fits all typical metal and timber stud spacing
- Wide range of thicknesses
- No waste
- Easy to handle and install without gaps
- Fire classification A1
- Can be used as a full fill solution in timberframe party walls to achieve zero effective U-value within SAP 2009

## Product properties and design

### Dimensions

Rockwool Flexi® suits standard stud and floor joist spacings and is available in the following sized slabs:

Length x Width (mm)	Standard available thicknesses (mm)
1200 x 600	50, 60, 70, 90, 100, 120 & 140
1200 x 400	50, 60, 100 & 140

## Packaging

Rockwool Flexi® is supplied palletised, compression packed in polyethylene bags, protected by a weatherproof covering allowing it to be stored outside. However the Flexi slabs should not be left permanently exposed to the elements.

## Installation guidance

Rockwool Flexi® slabs are light and easy to cut to any shape with a sharp knife.

- Ensuring a perfect insulation fit is essential to maintain the thermal and acoustic integrity of the wall. Typical softwood timber moisture contents can range between 6 - 30%, dependant on exposure to the elements.
- As a rule of thumb, timber will expand 1% for every 4% of moisture content.
- If insulation is installed when timber has high moisture content, it can result in a potential 6 mm vertical void on each side, when the timber dries out. Rockwool Flexi® expands into this void, ensuring thermal and acoustic integrity, whilst rigid insulations may leave a 6 mm gap, or even fall out.
- Where studs or joists are spaced at 400 mm centres, 1200 x 400 mm wide Rockwool Flexi® should be used.
- Rockwool Flexi® is also fast and easy to friction fit between floor joists from below, prior to fixing the plasterboard ceiling.
- Once installed Rockwool Flexi® does not require any maintenance.

# Rockwool Flexi®

## Thermal applications – timber frame walls

The additional thermal benefits offered by using high performance (HP) breather membranes (BM) and vapour control layers (VCL) over standard membranes are also shown in the tables below.

Effective thermal resistance (R-values) comparisons used for external cavities are:

- a) Standard BM = 0.18 m<sup>2</sup>/K/W
- b) Tyvek Reflex BM = 0.540 m<sup>2</sup>/K/W

Effective thermal resistance (R-values) comparisons used for internal cavities are:

- a) Standard vcl = 0.18 m<sup>2</sup>/K/W
- b) DuPont AirGuard vcl = 0.680 m<sup>2</sup>/K/W

### Construction 1: Cold frame

Timber frame cavity wall, standard construction, insulated with Rockwool Flexi® fully filling studs  
Internal finish: one layer plasterboard

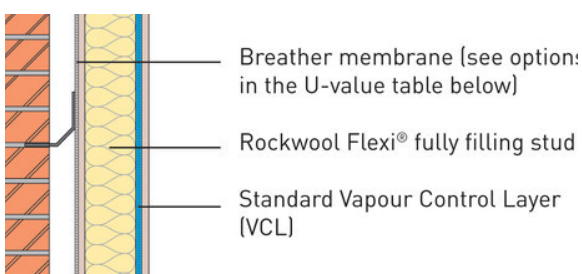

Breather membrane type	Standard	Tyvek Rellex
Rockwool Flexi® thickness (mm)	U-values (W/m <sup>2</sup> K)	U-values (W/m <sup>2</sup> K)
120	0.33	0.29
140	0.28	0.25

### Construction 1: Cold frame

Timber frame cavity wall with separate 25mm battened service void, insulated with Rockwool Flexi® fully filling studs  
Internal finish: one layer plasterboard

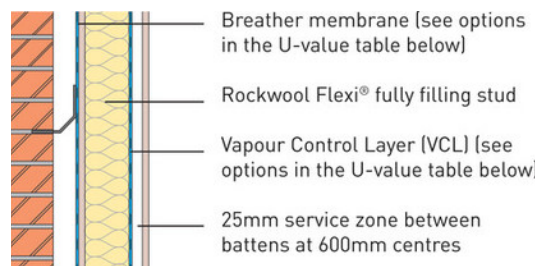

BM type >	Standard	Tyvek	Tyvek	Standard
VCL type >	Standard	Standard	AirGuard	AirGuard
RW Flexi® thickness (mm)	U-values W/m <sup>2</sup> K	U-values W/m <sup>2</sup> K	U-values W/m <sup>2</sup> K	U-values W/m <sup>2</sup> K
120	0.31	0.28	0.25	0.26
140	0.27	0.24	0.22	0.24

### Construction 3: Hybrid frame

Warm/hybrid timber frame cavity wall with Rockwool Flexi® insulation fully filling studs and 50mm of Rockwool HP Partial Fill, fixed to face of sheathing

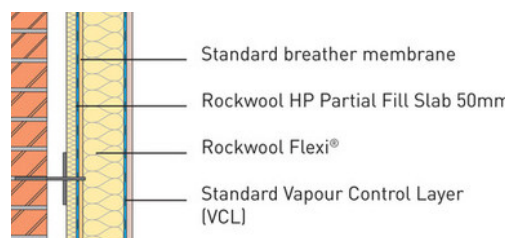

RW Flexi Thickness (mm)	U-values (w/m <sup>2</sup> K)
90	0.25
100	0.24
120	0.22
140	0.20

# Rockwool Flexi®

## Construction 4: Timber cladding or tile hanging (cold frame)

Timber frame\* wall with cladding, Rockwool Flexi® between studs.  
Plus 25mm service zone.

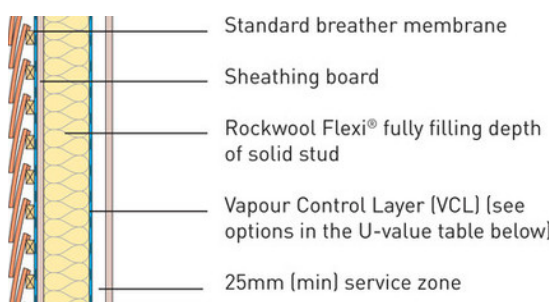

Flexi® between studs	U-values	
	Standard VCL	DuPont Airguard VCL
120mm	0.33	0.29
140mm	0.28	0.25
200mm	0.22	0.20

All calculations in the table allow for 15% timber bridging of main frame.

## Thermal applications – floors

### Suspended timber floor

Rockwool Flexi® is installed between joists, supported by polypropylene netting or breather membrane. The insulation should be fitted as close as is practical to the underside of floor deck to avoid any air gaps.

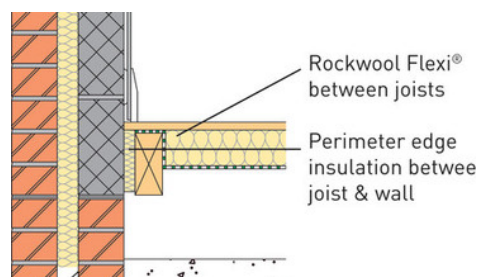

U-value	0.25	0.22	0.20	0.18
	W/m²K	W/m²K	W/m²K	W/m²K
P/A ratio	Thickness (mm)	Thickness (mm)	Thickness (mm)	Thickness (mm)
0.1	nil	nil	50	70
0.2	70	90	120	140
0.3	90	120	140	160
0.4	120	140	150	180
0.5	120	140	160	200
0.6	120	140	180	200
0.7	120	140	180	200
0.8	140	140	180	200
0.9	140	140	180	200
1.0	140	140	180	200

P/A: the exposed parameter length of the floor divided by the area of the floor.

## Thermal applications – Rafters

### Insulation between rafters only

Tiles/slates on 25mm counter battens on BBA approved roof breather membrane with, Rockwool Flexi® fitted between rafters. An airtight vapour control membrane is stapled to the underside of the rafters, with joints lapped and sealed. The ceiling should be finished internally with 12.5mm plasterboard:

# Rockwool Flexi®

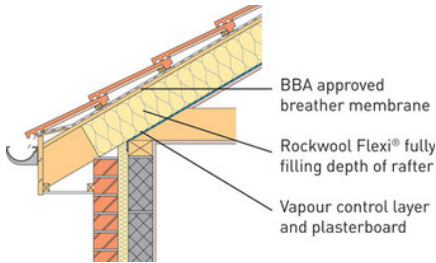

## RW Flexi® Thickness (mm) U-values (w/m²K)

200 (2 x 100)	0.21
220 (120+100)	0.19
240 (2 x 120)	0.18

Note: U-values are based on 38mm wide rafters spaced at 600mm centres.

## Acoustic applications – walls

Rockwool Flexi® works in two distinct ways to reduce noise, either by impeding the transmission of sound through an element of the structure, or by absorbing sound at the surface.

### Acoustic and thermal insulation for timber frame party walls to help reduce Party wall bypass

Rockwool Flexi® slabs can be used to address both acoustic and thermal solutions in new build timber frame cavity party walls between adjoining apartments, semi-detached and terraced houses.

The Flexi product can be used as a full fill solution to achieve a zero effective U-value within SAP 2009 which is used to calculate energy consumption for 2010 Building Regulations – Approved Document L (England & Wales) and Technical Handbook Section 6 (Scotland).

## Robust Details: separating timber framed walls

Robust Details reference – E-WT-1

- Without sheathing board
- Twin timber frames (for use in conjunction with timber frame dwellings and apartments)

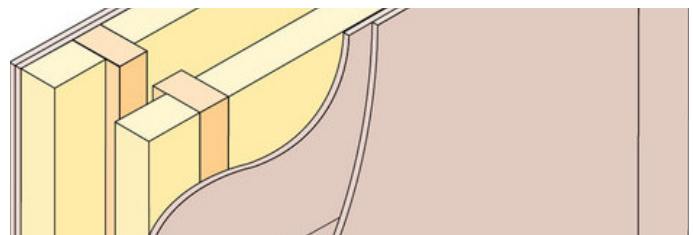

Rockwool SoundPro robust detail guidance specification

The following are required:

- Wall width: a minimum of 240 mm between inner faces of wall linings and a 50 mm gap between studs.
- Wall lining: 2 or more layers of gypsum-based board (total nominal mass per unit area 22 kg/m²) both sides.
- Rockwool Flexi®: a minimum of 60 mm on both sides

Robust Details reference – E-WT-2

Separating wall – timber frame

- With sheathing board
- Twin timber frames (for use in conjunction with timber framed dwellings and apartments)

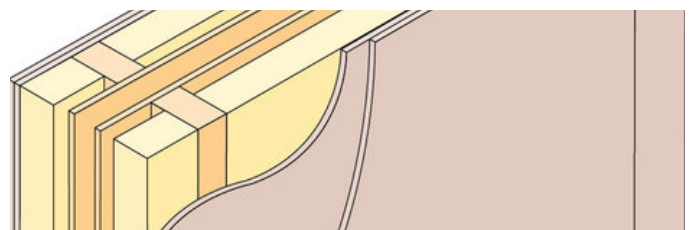

# Rockwool Flexi®

Rockwool SoundPro robust detail guidance specification

The following are required:

- Wall width: a minimum of 240 mm between inner faces of wall linings and a . 50 mm gap between studs.
- Wall lining: 2 or more layers of gypsum-based board (total nominal mass per unit area 22 kg/m<sup>2</sup>) both sides.
- Rockwool Flexi®: a minimum of 60 mm on both sides

Robust Details reference – E-WS-1

Separating wall – steel frame

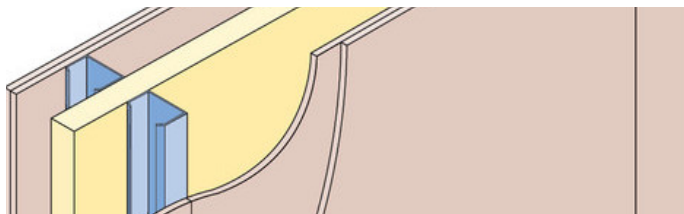

Twin metal frames for use in lightweight steel frame houses and flats/apartments (for use in conjunction with light steel framed dwellings and apartments).

Rockwool SoundPro robust detail guidance specification

The following are required:

- Wall width: a minimum of 200mm between inner faces of wall linings
- Wall lining: 2 or more layers of gypsum-based board (total nominal mass per unit area 22 kg/m<sup>2</sup>) both sides
- Rockwool Flexi®: a minimum of 50mm

Please note: The steel frame profiles shown are indicative only. Other profiles are acceptable. This robust detail is only suitable for use in lightweight steel frame houses and flats/apartments.

## Acoustic applications – partitions

Rockwool Flexi® will provide both acoustic and fire benefits when used in partitions.

Lightweight domestic timber stud partition: meeting Approved Document E2 (domestic internal partitions)

Solution 1. Timber frame

The following are required:

- Studs: 38 × 75 timber studs @ 600mm centres
- Facings: 1 layer 12.5mm acoustic rated plasterboard (11 kg/m<sup>2</sup>) each side
- Insulation: a minimum of 50mm of Rockwool Flexi®

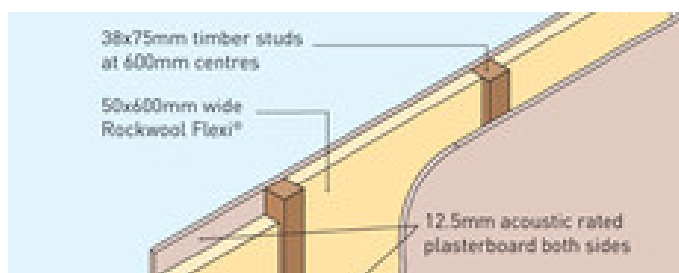

### Results:

Weighted sound reduction (Rw dB)	40
Fire resistance (minutes)	30
Max height (metres)	3
Nominal thickness (millimetres)	100



# Rockwool Flexi®

## Solution 2. Metal frame

Lightweight domestic metal stud

The following are required:

- Studs: 50mm metal studs @ 600mm centres
- Facings: 1 layer of 12.5mm standard plasterboard (8 kg/m<sup>2</sup>) each side
- Insulation: a minimum of 50mm of Rockwool Flexi®

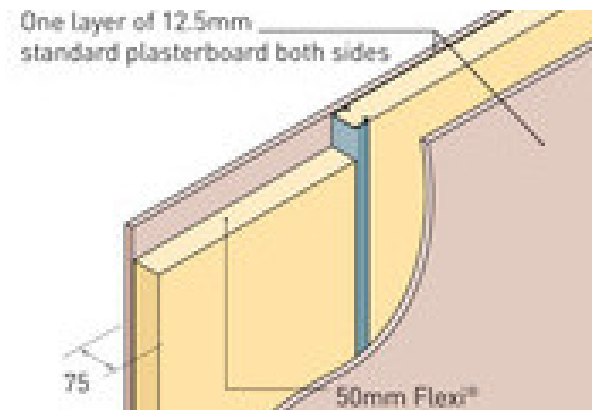

### Results:

Weighted sound reduction (Rw dB)	41
Fire resistance (minutes)	30
Max height (metres)	2.5
Nominal thickness (millimetres)	75

Enhanced performance (timber frame)

Typical office partition adjacent to factory

The following are required:

- Studs: 38 x 75 timber studs @ 600mm centres
- Facings: 2 layers of 12.5 mm standard plasterboard (8 kg/m<sup>2</sup>) each side
- Insulation: a minimum of 50mm of Rockwool Flexi®

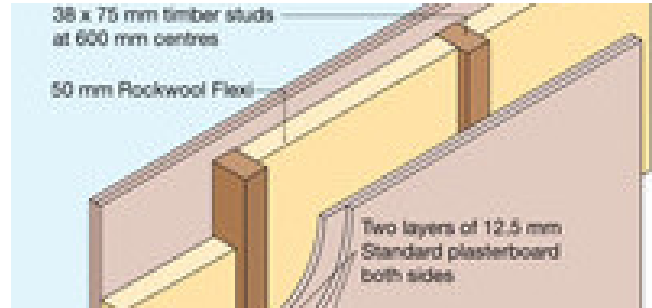

### Results:

Weighted sound reduction (Rw dB)	46
Fire resistance (minutes)	60
Max height (metres)	3
Nominal thickness (millimetres)	125

Enhanced performance (metal frame): schools, offices and public buildings: NBS Plus Clause K10:115, K10:125

The following are required:

- Studs: 70mm metal studs @ 600mm centres
- Facings: 2 layers of 15.0 mm acoustic rated plasterboard (26 kg/m<sup>2</sup>) each side
- Insulation: a minimum of 70mm of Rockwool Flexi®

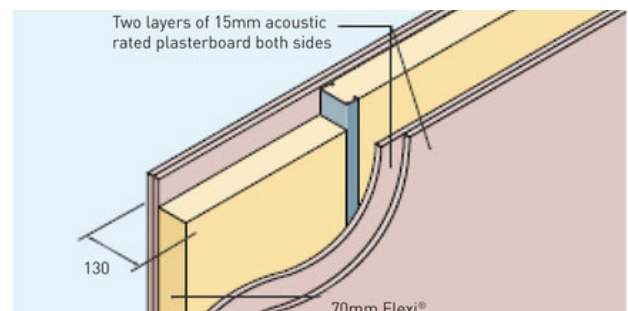

### Results:

Weighted sound reduction (Rw dB)	57
Fire resistance (minutes)	90
Max height (metres)	4.6
Nominal thickness (millimetres)	130

# Rockwool Flexi®

## Alternative Rockwool systems for ADE compliance

### New build separating timber floor

The following Rockwool solutions have the potential to meet the requirements set out in Part E Section 3 and provide a minimum fire resistance of 60 minutes.

Airborne: Rw 54 dB (Rw 66 - 12 Ctr)

Impact: Lnw 54 dB

Test Report ref. L03 272 & 273

### Rockwool floor type

The following are required:

- 18mm of tongue and groove flooring grade chipboard
- 15mm acoustic rated plasterboard with a minimum mass 12.5 kg/m<sup>2</sup> mass per unit area
- 50mm of Rockwool Rockfloor resilient layer
- 15mm of OSB on 200 × 50mm timber joists @ 400mm centres
- 100 mm of Rockwool Flexi® between joists
- Resilient bars fixed at right angles to joists @ 400mm centres
- Ceiling finish: , 2 layers of 15 mm acoustic rated plasterboard (26 kg/m<sup>2</sup>)
- Pre-completion site testing required on site

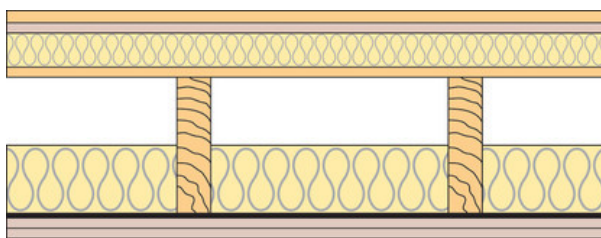

For details of this acoustic solution with downlights, refer to SoundPro brochure, Section E1 (New build), page 3, solution 6.

## Internal floors

Rockwool system for ADE compliance to ADE Section 5 – internal floors, within the same dwellings

Timber joist internal floor (domestic internal floor)

To meet part E2: Rw 40 dB Test Report ref. L03 264 & 265

The following are required:

- 18mm of tongue and groove flooring grade chipboard with a mass per unit area of 12.4 kg/m<sup>2</sup>
- Timber joists @ 400mm centres
- 100mm of Rockwool Flexi® between joists
- A single layer of standard 12.5mm plasterboard ceiling with a , mass per unit area of 8 kg/m<sup>2</sup>

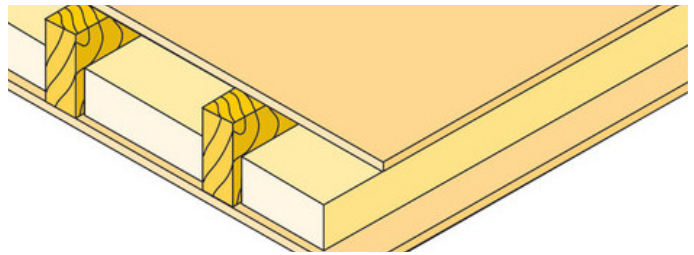

## Acoustic applications – separating floors (material change of use) ADE Section 4

ADE Construction guidance specifications for material change of use separating timber floor treatment 2:

Platform floor with absorbent material:

NBS Plus Clause K11:215, 225, 235 & 245

The following are required:

- A minimum of 2 layers of board material to provide minimum a total mass of 25 Kg/m<sup>2</sup>, spot bonded together with joints staggered (eg 18mm of tongue and groove flooring grade chipboard and 19mm of plasterboard plank)



# Rockwool Flexi®

- 25mm (min) Rockwool Rockfloor resilient layer laid on
- The floating layer to be loose laid over the Rockfloor
- Existing floor deck on existing timber floor joists
- 100mm of Rockwool Flexi®
- Existing ceiling should be upgraded to 20 kg/m<sup>2</sup>. If the existing ceiling is of lath & plaster it should be retained, providing it satisfies Part B – Fire Safety. (if in doubt then , underdraw the ceiling with an additional layer of 12.5 mm fire rated plasterboard and screw into the joists)
- Pre-completion site testing

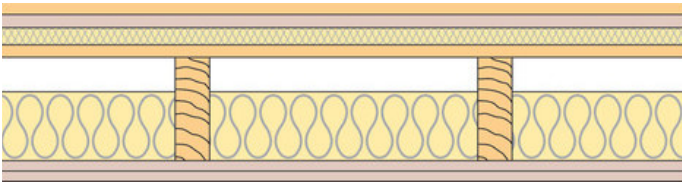

- If the existing masonry wall is not plastered or is less than 100mm thick then independent panels should be applied to both sides
- Pre-completion site testing

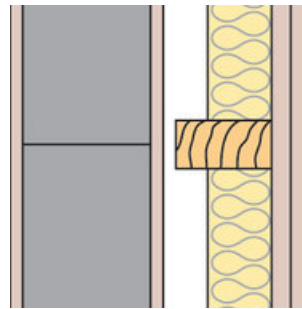

## Acoustic applications – separating walls

(material change of use) ADE Section 4

ADE construction guidance specifications for wall treatment 1: existing solid masonry wall with independent panel(s);

The following are required:

- A minimum of 100mm of existing solid masonry wall, plastered on both faces
- Independent timber or steel studs. A minimum 10 mm gap to be maintained between the frame and the existing wall
- 50mm of Rockwool Flexi® between studs
- 2 layers of plasterboard at a minimum of 20 kg/m<sup>2</sup> (approximately equal to 2 × 15 mm layers)
- Avoid flanking transmission: seal perimeter edges of new plasterboard with tape or Rockwool Acoustic Sealant

# Rockwool Flexi®

## Standards and quality approvals

### Fire classification



Rockwool Flexi® achieves a reaction to fire classification of A1, as defined in EN13501-1.

### Fire protection: upgrading existing timber floor to achieve one hour fire resistance

One hour fire resisting floor using Rockwool Flexi®  
Remove floor boards and install a continuous run of 25 mm  $\varnothing$  chicken wire mesh across the whole floor. Form the mesh so that it follows the profile of the joists and the top face of the ceiling lining. 100 mm Rockwool Flexi® to fit tightly between the joists and supported by the mesh. Lay new floor of either (a) 19 mm flooring grade t & g chipboard or (b) square edged boards with a layer of 3 mm hardboard above or below the boards.

1 hour fire resistant floor based on fire test to BS476: Part 21

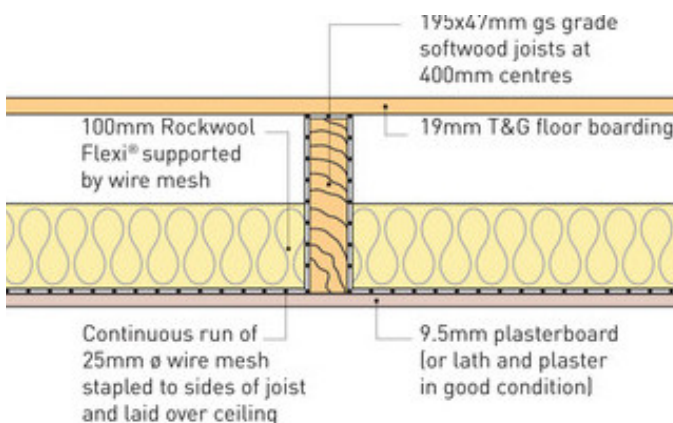

## Product performance

### Thermal Performance

Rockwool Flexi® has a thermal conductivity of 0.038 W/mK and 0.035W/mK at 140 mm thickness.

### Ordering

Rockwool Flexi®: Please quote thickness, width and area required.

Rockwool Rockfloor: Please quote thickness and area required.

Rockwool HP Partial Fill Slabs: Please quote thickness and area required.



Following major investment in our production processes, our revolutionary new RockVac technology allows us to add significant

compression to Flexi products. The additional vacuum extraction process allows us to supply loaded pallets containing a considerably larger volume of products and all without the need for additional storage space.

## Sustainability

As an environmentally conscious company, Rockwool promotes the sustainable production and use of insulation and is committed to a continuous process of environmental improvement.

# Rockwool Flexi®

---

All Rockwool products provide outstanding thermal protection as well as four added benefits:



■ Fire resistance

- Acoustic comfort
- Sustainable materials
- Durability

## Health and safety

---

The safety of Rockwool stone wool is confirmed by current UK and Republic of Ireland health & safety regulations and EU directive 97/69/EC: Rockwool fibres are not classified as a possible human carcinogen.

A Material Safety Data Sheet can be downloaded from [www.rockwool.co.uk](http://www.rockwool.co.uk) or requested from Rockwool Technical Support (0871 222 1780) to assist in the preparation of risk assessments, as required by the Control of Substances Hazardous to Health Regulations (COSHH).

## Environment

---

Relying on entrapped air for its thermal properties, we are proud to say that Rockwool insulation does not contain (and has never contained) gases that have ozone depleting potential (ODP) or global warming potential (GWP). Rockwool therefore complies with the relatively modest threshold of GWP<5 included in documents such as the Code for Sustainable Homes.

Rockwool is increasingly involved in recycling waste Rockwool material that may be generated during installation or at end of life.

We are happy to discuss the individual requirements of contractors and users considering returning Rockwool materials to our factory for recycling.

## More information

For further details visit our website at [www.rockwool.co.uk](http://www.rockwool.co.uk) or phone Rockwool Technical Support on 0871 222 1780

# Rockwool Flexi®

---

Rockwool Limited reserves the right to alter or amend the specification of products without notice as our policy is one of constant improvement. The information contained in this data sheet is believed to be correct at the date of publication.

Whilst Rockwool will endeavour to keep its publications up to date, readers will appreciate that between publications there may be pertinent changes in the law, or other developments affecting the accuracy of the information contained in this data sheet.

The above applications do not necessarily represent an exhaustive list of applications for Rockwool Flexi®. Rockwool Limited does not accept responsibility for the consequences of using Rockwool Flexi® in applications different from those described within this data sheet. Expert advice should be sought where such different applications are contemplated, or where the extent of any listed application is in doubt.

Rockwool Limited  
Pencoed  
Bridgend  
CF35 6NY

26-28 Hammersmith Grove  
Hammersmith  
London  
W6 7HA

info@rockwool.co.uk  
www.rockwool.co.uk

Printed on recycled paper.  
Available as a PDF  
document.

© Copyright Rockwool  
November 2011.